

NOZZLE INDEX

Connection	Size	Type	DIN
N1	DN 80 PN16	Inlet	DIN 2633, C
N2	DN 80 PN16	Outlet	DIN 2633, C
N3	Rp 1/4	Vent	DIN 2999
N4	Rp 1/4	Manometer	DIN 2999
N5	Rp 1/2	Drain	DIN 2986
N6	Rp 1/4	Differential Pressure Measurement	DIN 2999
N7	Rp 1/4	Differential Pressure Measurement	DIN 2999

SPECIFICATION

Max. allow. Pressure	10 bar
Test Pressure	14,3 bar
Max. allow. Temperature	-10/+80°C
Volume	28 l
Material Housing	AISI 316
Material Gasket	O-Ring FPM
Material Bolts	Stainless Steel
Weight	42 kg

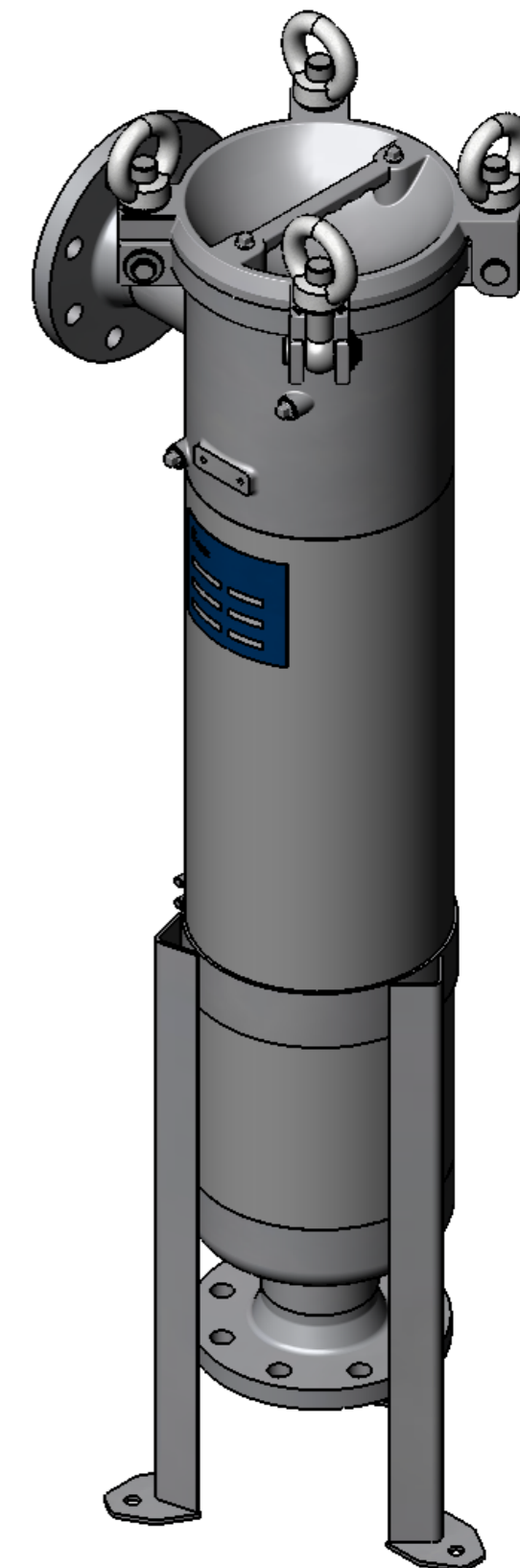

Date	14.02.2012	Name	Leekes	Type	BFOS2-10/F80-A4
				Article-No.	5175642800
				Associated Drawing:	10-1268