

### NOZZLE INDEX

Connection	Size	Type	DIN
N1	DN 50 PN16	Inlet	DIN 2633, C
N2	DN 50 PN16	Outlet	DIN 2633, C
N3	Rp 1/2	Vent	DIN 2999
N4	Rp 1/2	Drain	DIN 2986
N5	Rp 1/2	Drain	DIN 2986

### SPECIFICATION

Number of cartridges	7
Cartridge length	744-762 mm
Max. allow. pressure	10 bar
Test pressure	14,3 bar
Max. allow. temperature	-10/+80°C
Volume	45 l
Material housing	AISI 316
Material gasket	O-ring FPM
Material bolts	Stainless steel
Weight	48 kg

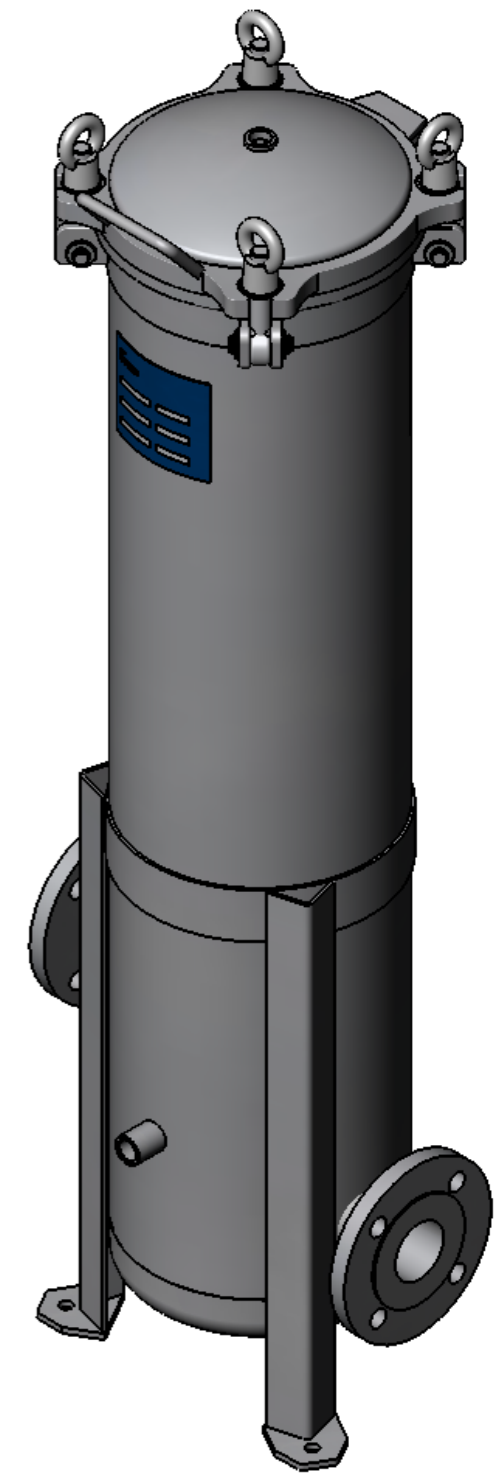

Date	07.01.2014	Name	Leekes	Type	7FWK3-10/F50-A4
				Article-No.	1757732350
Associated Drawing: 10-1163 Rev.0					