

**DOE FILTER CARTRIDGE
(DOUBLE-OPEN-END)**

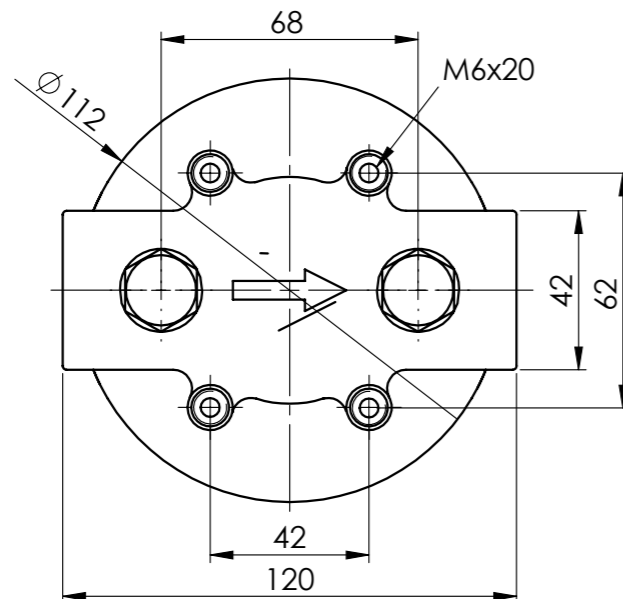
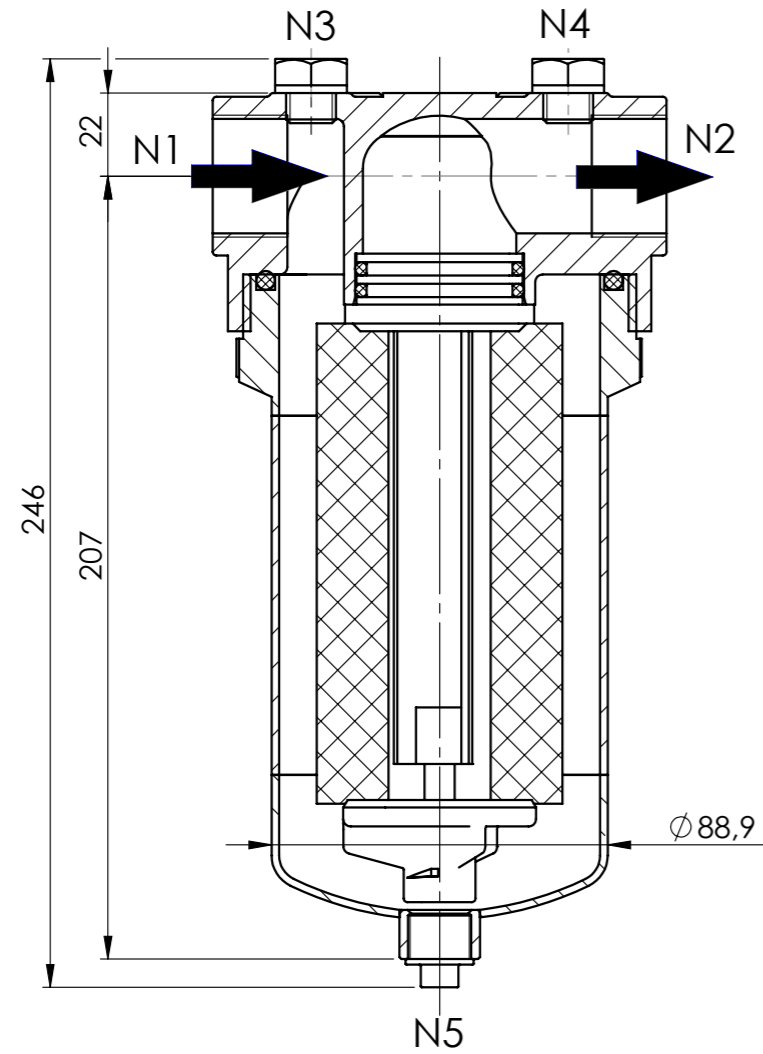

NOZZLE INDEX

Connection	Size	Type	DIN
N1	Rp 1	Inlet	DIN 2999
N2	Rp 1	Outlet	DIN 2999
N3	Rp 1/4	Vent	DIN 2999
N4	Rp 1/4	Vent	DIN 2999
N5	Rp 3/8	Drain	DIN 2986

SPECIFICATION

Max. allow. pressure	25 bar
Max. allow. temperature	-10/+80°C
Volume	1 l
Material Filter Head	AISI 316
Material Filter Sump	AISI 316
Material Insert	AISI 316
Material Gaskets	FPM
DOE - Cartridge Length	124 - 128 mm
Weight	3,2 kg

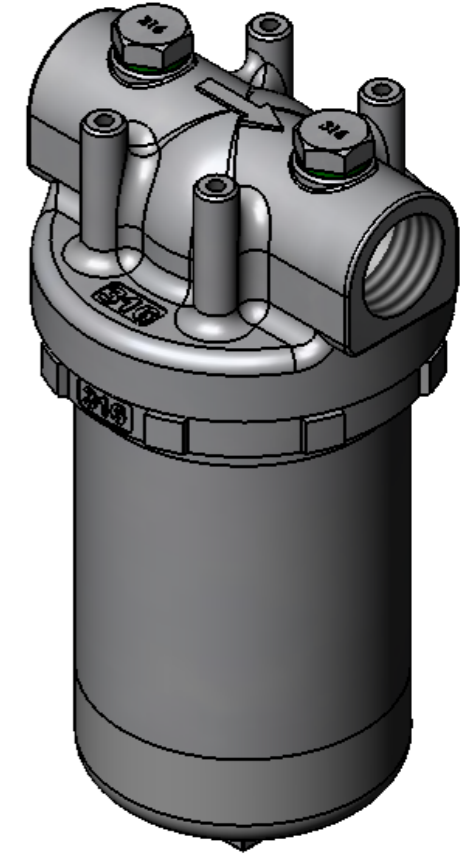

analog fig

Date	23.05.2012	Name	Leekes	Type	1FU0-25/25-A4F
Proof.					
Resp.					
Norm					
				Article-No.	1754202025
				acc. drawing: 10-1269	Repl. for.